

# GRUA TORRE / TOWER CRANE

GRUE A TOUR / TURMDREHKRAN

БАШЕННЫЙ КРАН / رافعة برجية

# J780PA.64



EN 14439  
C25

UNE-EN-ISO 9001

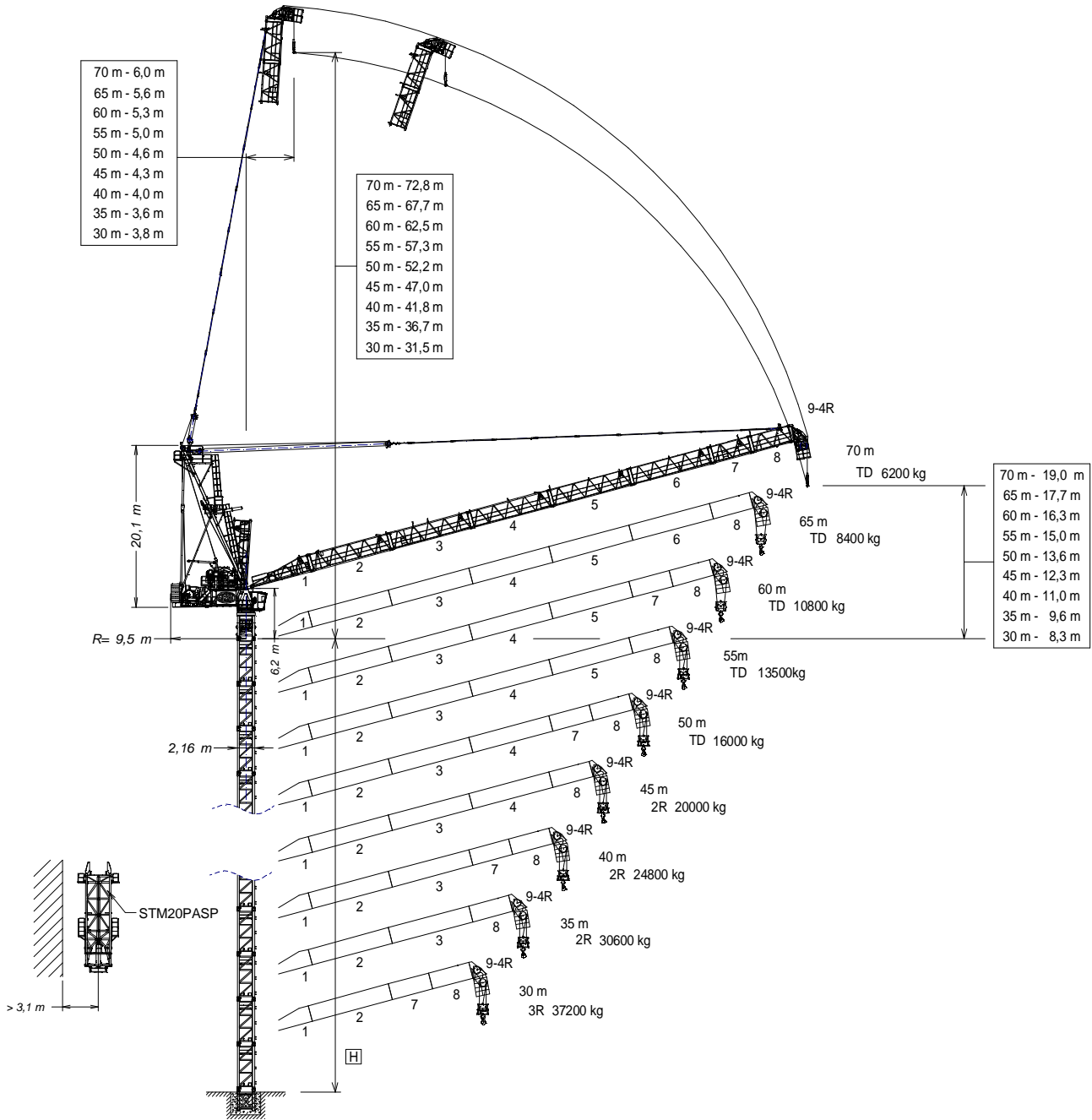

H =

Máxima altura de torre sin arriostrar (m).  
Maximum tower height without fastening (m).  
Hauteur maximale de tour sans ancrage (m).  
Maximale Höhe ohne Verstreben (m).  
Максимальная высота башни без крепления (м).  
أقصى ارتفاع للبرج بدون ربط (م)

\* Tramo pluma / Jib section / Tronçon de fleche  
Auslegerabschnitt / Секция стрелы / أجزاء الذراع

\*Tramo pluma 1 / Jib setion 1 -----800.40.450  
\*Tramo pluma 2 / Jib setion 2 -----800.41.700  
\*Tramo pluma 3 / Jib setion 3 -----800.42.700  
\*Tramo pluma 4 / Jib setion 4 -----800.43.800  
\*Tramo pluma 5 / Jib setion 5 -----800.44.600  
\*Tramo pluma 6 / Jib setion 6 -----800.45.700  
\*Tramo pluma 7 / Jib setion 7 -----800.46.800  
\*Tramo pluma 8 / Jib setion 8 -----214.47.000  
\*Tramo pluma 9-4R / Jib setion 9-4R----801.48.000

ASP20 -----212.21.200  
TSP20 -----212.32.400  
TSP20-5,6 -----212.31.000  
TSP24-5,6 -----212.32.000  
TSP24/TSP20 -----212.36.000

Fecha / Date: 11/10/2022

FEM 1005 - C25



Reservado el derecho a modificaciones sin previo aviso. Declinamos toda responsabilidad derivada de la información proporcionada / Subject to modification, without prior notice. This information is supplied without liability / L'entreprise se réserve le droit de procéder à des modifications sans préavis. Nous déclinons toute responsabilité quant aux informations fournies / Das Recht auf Änderungen ohne vorherige Ankündigung bleibt vorbehalten. Wir übernehmen keine Gewähr für die gemachten Angaben / Мы оставляем за собой право на внесение изменений без предварительного уведомления. Мы снимаем с себя любую ответственность в отношении предоставленной информации / حقوق التغيير محفوظة دون إشعار مسبق. دون أدنى مسؤولية عن المعلومات المقدمة

TD

(H) ESTACIONARIA / STATIONARY

STATIONAIRE / STATIONÄR / СТАЦИОНАРНОЕ СОСТОЯНИЕ / ثابتة

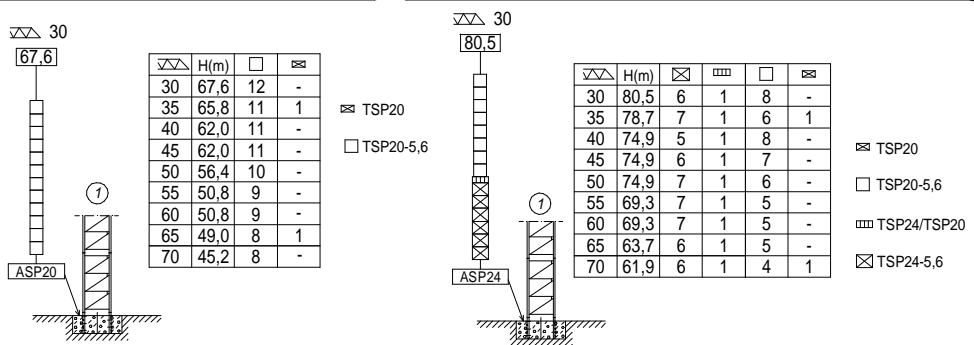

2R

(H) ESTACIONARIA / STATIONARY

STATIONAIRE / STATIONÄR / СТАЦИОНАРНОЕ СОСТОЯНИЕ / ثابتة

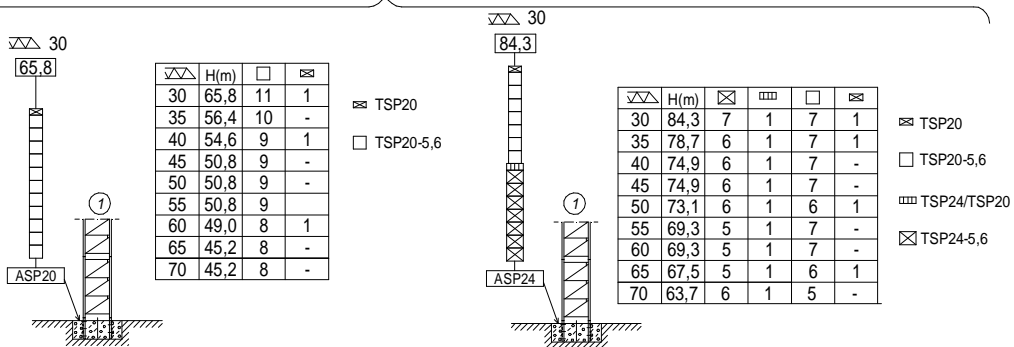

3R

(H) ESTACIONARIA / STATIONARY

STATIONAIRE / STATIONÄR / СТАЦИОНАРНОЕ СОСТОЯНИЕ / ثابتة

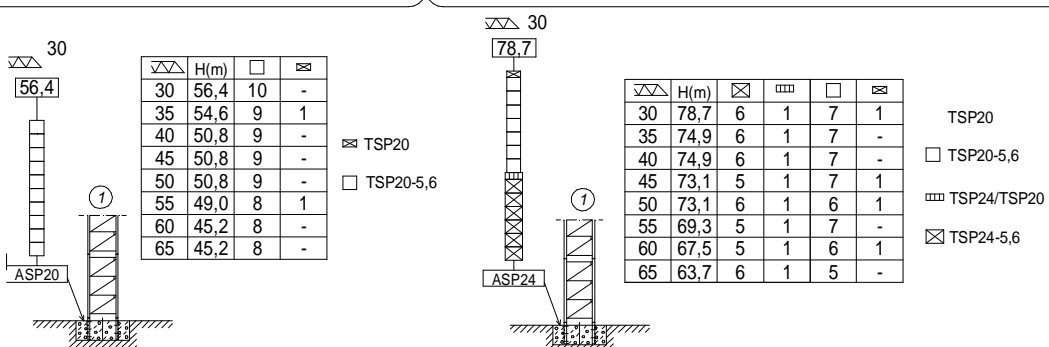

4R

(H) ESTACIONARIA / STATIONARY

STATIONAIRE / STATIONÄR / СТАЦИОНАРНОЕ СОСТОЯНИЕ / ثابتة

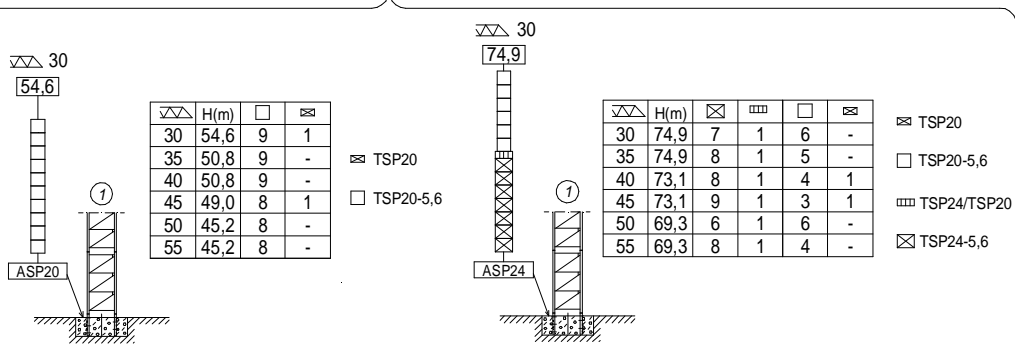





Fecha / Date: 11/10/2022



FEM 1005 - C25





Reservado el derecho a modificaciones sin previo aviso. Declinamos toda responsabilidad derivada de la información proporcionada / Subject to modification, without prior notice. This information is supplied without liability / L'entreprise se réserve le droit de procéder à des modifications sans préavis. Nous déclinons toute responsabilité quant aux informations fournies / Das Recht auf Änderungen ohne vorherige Ankündigung bleibt vorbehalten. Wir übernehmen keine Gewähr für die gemachten Angaben / Мы оставляем за собой право на внесение изменений без предварительного уведомления. Мы снимаем с себя любую ответственность в отношении предоставленной информации / حقوق التغيير محفوظة دون إشعار مسبق. دون أدنى مسؤولية عن المعلومات المقدمة

		Cargas máximas / Maximum loads / Charges maximales / Höchstlasten / Максимальные нагрузки / أقصى حمولة										
TD (t)		TD-16 t										
	TD 16t @ (m)	Alcance del gancho [m] / Hook reach [m] / Portée du crochet (m) Reichweite des Hakens (m) / Радиус действия крюка (m) / مدى الخطاف										
		25	30	35	40	45	50	55	60	65	70	
70	51,0	16,0	16,0	16,0	16,0	16,0	16,0	13,4	10,6	8,2	6,2	
65	51,0	16,0	16,0	16,0	16,0	16,0	16,0	13,4	10,7	8,4	-	
60	51,1	16,0	16,0	16,0	16,0	16,0	16,0	13,5	10,8	-	-	
55	51,1	16,0	16,0	16,0	16,0	16,0	16,0	13,5	-	-	-	
50	50,0	16,0	16,0	16,0	16,0	16,0	16,0	-	-	-	-	
45	45,0	16,0	16,0	16,0	16,0	-	-	-	-	-	-	
40	40,0	16,0	16,0	16,0	-	-	-	-	-	-	-	
35	35,0	16,0	16,0	-	-	-	-	-	-	-	-	
30	30,0	16,0	16,0	-	-	-	-	-	-	-	-	

			Cargas máximas / Maximum loads / Charges maximales / Höchstlasten / Максимальные нагрузки / أقصى حمولة										
2R (t)			2R (t)										
	2R max (t)	@ (m)	Alcance del gancho [m] / Hook reach [m] / Portée du crochet (m) Reichweite des Hakens (m) / Радиус действия крюка (m) / مدى الخطاف										
			25	30	35	40	45	50	55	60	65	70	
70	28,0	36,3	28,0	28,0	28,0	23,6	18,8	15,0	11,8	9,2	7,0	5,1	
65	32,0	33,4	32,0	32,0	29,7	23,6	18,9	15,1	12,0	9,5	7,3	-	
60	32,0	33,4	32,0	32,0	29,7	23,7	19,0	15,3	12,2	9,7	-	-	
55	32,0	33,4	32,0	32,0	29,7	23,8	19,1	15,4	12,4	-	-	-	
50	32,0	33,6	32,0	32,0	30,0	24,1	19,5	15,8	-	-	-	-	
45	32,0	33,9	32,0	32,0	30,5	24,6	20,0	-	-	-	-	-	
40	32,0	34,0	32,0	32,0	30,6	24,8	-	-	-	-	-	-	
35	32,0	34,0	32,0	32,0	30,6	-	-	-	-	-	-	-	
30	32,0	30,0	32,0	32,0	-	-	-	-	-	-	-	-	















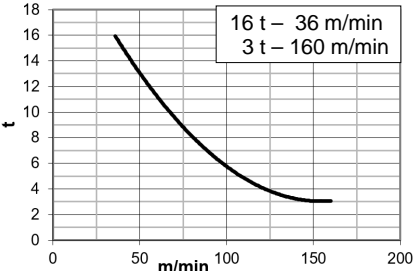
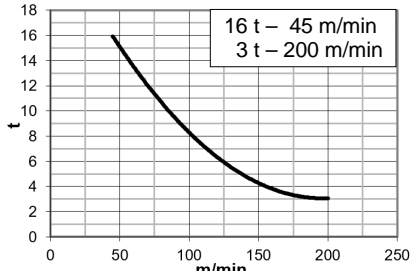

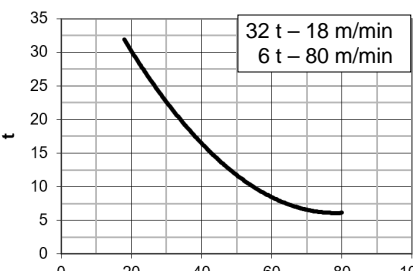
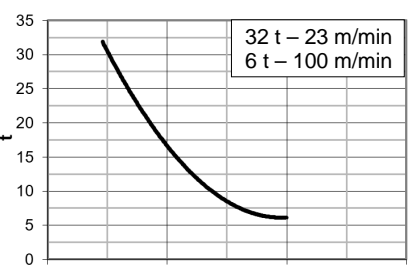
			Cargas máximas / Maximum loads / Charges maximales / Höchstlasten / Максимальные нагрузки / أقصى حمولة										
3R (t)			3R (t)										
	3R max (t)	@ (m)	Alcance del gancho [m] / Hook reach [m] / Portée du crochet (m) Reichweite des Hakens (m) / Радиус действия крюка (m) / مدى الخطاف										
			20	25	30	35	40	45	50	55	60	65	
65	42,0	27,1	42,0	42,0	36,0	28,2	22,3	17,7	14,0	11,0	8,5	6,4	
60	48,0	24,6	48,0	46,9	36,0	28,3	22,4	17,9	14,2	11,3	8,8	-	
55	48,0	24,6	48,0	46,9	36,1	28,4	22,6	18,1	14,5	11,5	-	-	
50	48,0	24,7	48,0	47,2	36,4	28,7	23,0	18,5	14,9	-	-	-	
45	48,0	24,8	48,0	47,5	36,8	29,2	23,5	19,1	-	-	-	-	
40	48,0	24,8	48,0	47,5	37,0	29,5	23,9	-	-	-	-	-	
35	48,0	24,8	48,0	47,5	37,1	29,7	-	-	-	-	-	-	
30	48,0	24,8	48,0	47,5	37,2	-	-	-	-	-	-	-	

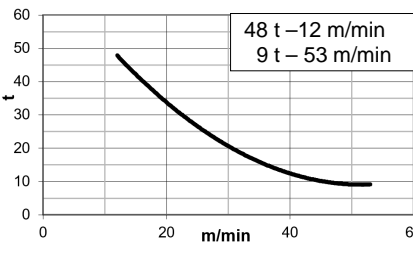
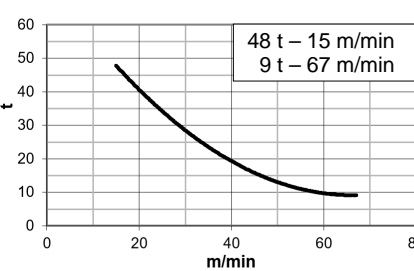
			Cargas máximas / Maximum loads / Charges maximales / Höchstlasten / Максимальные нагрузки / أقصى حمولة										
4R (t)			4R - 64 t										
	4R 64t @ (m)	Alcance del gancho [m] / Hook reach [m] / Portée du crochet (m) Reichweite des Hakens (m) / Радиус действия крюка (m) / مدى الخطاف											
		15	20	25	30	35	40	45	50	55			
55	19,5	64,0	62,0	46,0	35,4	27,8	22,1	17,6	14,1	11,2	-	-	
50	19,5	64,0	62,0	46,2	35,7	28,1	22,5	18,1	14,6	-	-	-	
45	19,6	64,0	62,4	46,7	36,2	28,8	23,2	18,8	-	-	-	-	
40	19,6	64,0	62,4	46,9	36,5	29,1	23,6	-	-	-	-	-	
35	19,6	64,0	62,4	47,0	36,7	29,4	-	-	-	-	-	-	
30	19,6	64,0	62,4	47,1	36,9	-	-	-	-	-	-	-	

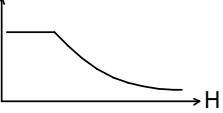
Fecha / Date: 11/10/2022

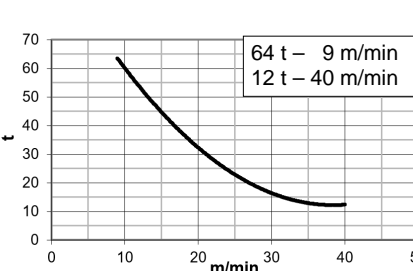
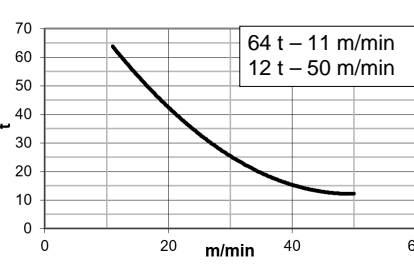
 FEM 1005 - C25

Reservado el derecho a modificaciones sin previo aviso. Declinamos toda responsabilidad derivada de la información proporcionada / Subject to modification, without prior notice. This information is supplied without liability / L'entreprise se réserve le droit de procéder à des modifications sans préavis. Nous déclinons toute responsabilité quant aux informations fournies / Das Recht auf Änderungen ohne vorherige Ankündigung bleibt vorbehalten. Wir übernehmen keine Gewähr für die gemachten Angaben / Мы оставляем за собой право на внесение изменений без предварительного уведомления. Мы снимаем с себя любую ответственность в отношении предоставленной информации / حقوق التغيير محفوظة دون إشعار مسبق. دون أدنى مسؤولية عن المعلومات المقدمة

*opcional *optional *en option *optional *опция *اختياري												
	<b>EC150160VF</b> <b>110 kW</b>	<b>* EC180200VF</b> <b>132 kW</b>	<b>OG4007VF</b> <b>2x15 kW</b>	<b>EP15020VF</b> <b>110 kW</b>								
			0... 0,7 r/min sl/min	2 min								
			 <b>400V 50Hz</b>  <b>P<sub>TOTAL</sub> = 250 kW</b> (EC150160VF + OG4007VF + EP15020VF)  <b>P<sub>TOTAL</sub> = * 272 kW</b> (*EC180200VF + OG4007VF + EP15020VF)									
			  									
			 <b>ecoMode</b>   <table style="margin-left: 20px;"> <tr><td>TD</td><td>912 m</td></tr> <tr><td>2R</td><td>456 m</td></tr> <tr><td>3R</td><td>304 m</td></tr> <tr><td>4R</td><td>228 m</td></tr> </table>  1161 m		TD	912 m	2R	456 m	3R	304 m	4R	228 m
TD	912 m											
2R	456 m											
3R	304 m											
4R	228 m											

**LISTA DE EMBARQUE / PACKING LIST / LISTE DE COLISAGE / KOLLI LISTE / СПИСОК ПОСТАВКИ / قائمة التحميل / J780PA.64**

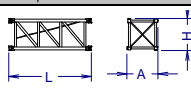
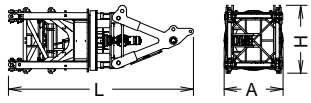
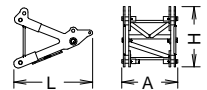



DENOMINACIÓN / DENOMINATION / DÉSIGNATION / BEZEICHNUNG / НАЗВАНИЕ / اسم	L [m]	A [m]	H [m]	P / W [kg]
Torre / Tower Tour / Turm / Башня / برج TSP20 TSP20-5,6	 4,374 6,164	2,285 2,285	2,383 2,383	5615 7665
Torre asiento pista, torre superior y orientación Slewing table, top tower and slewing mechanism Tour pivot + tour supérieure + mécanisme d'orientation Turmsitz, + oberer Turm + Ausrichtung Сиденье площадки + верхняя башня + поворотный механизм برج وحدة الدوران + البرج العلوي + آلية الدوران	 7,245	2,315	2,625	25540
Punta de torre / Top tower Tour supérieure / Turmspitze / верхняя башня / رأس البرج	 3,200	2,275	2,435	5895

Fecha / Date: 11/10/2022

 **FEM 1005 - C25**

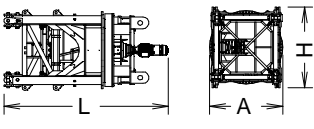
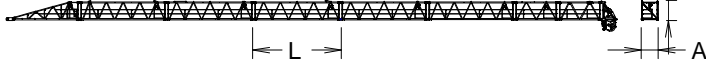
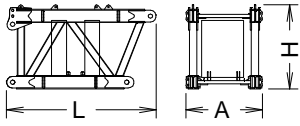
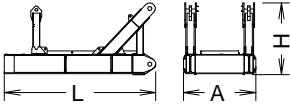
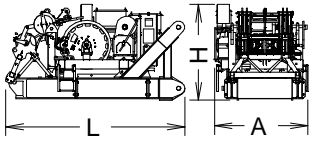
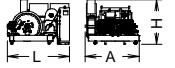
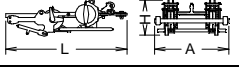
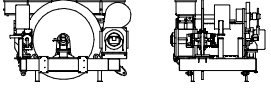
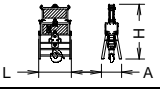
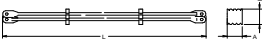
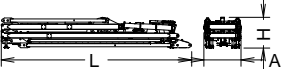

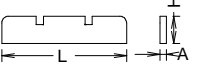
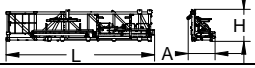
Reservado el derecho a modificaciones sin previo aviso. Declinamos toda responsabilidad derivada de la información proporcionada / Subject to modification, without prior notice. This information is supplied without liability / L'entreprise se réserve le droit de procéder à des modifications sans préavis. Nous déclinons toute responsabilité quant aux informations fournies / Das Recht auf Änderungen ohne vorherige Ankündigung bleibt vorbehalten. Wir übernehmen keine Gewähr für die gemachten Angaben / Мы оставляем за собой право на внесение изменений без предварительного уведомления. Мы снимаем с себя любую ответственность в отношении предоставленной информации / حقوق التغيير محفوظة دون إشعار مسبق. دون أدنى مسؤولية عن المعلومات المقدمة

DENOMINACIÓN / DENOMINATION / DÉSIGNATION / BEZEICHNUNG / НАЗВАНИЕ / اسم		L [m]	A [m]	H [m]	P / W [kg]	
Torre asiento pista + base punta de torre + orientación Slewing table + tower head base + slewing mechanism Tour pivot + base du porte-flèche + mécanisme d'orientation Turmsitz + Turmspitzenbasis + Ausrichtung Сиденье площадки + основание верхней секции башни + поворотный механизм برج وحدة الدوران + البرج العلوي + آلية الدوران			5,200	2,315	2,545	19645
Tramo de pluma Jib section Tronçon de flèche Auslegerabschnitt Секция стрелы أجزاء الذراع	[1]		8,884	2,271	2,259	3940
	[2]		10,583	2,150	2,369	4315
	[3]		10,583	1,988	2,277	3710
	[4]		10,583	1,988	2,404	3320
	[5]		10,583	1,988	2,277	3290
	[6]		10,583	1,988	2,258	2880
	[7]		5,406	1,988	2,270	1815
	[8]		5,396	1,988	2,279	2305
[9-4R]		1,997	2,032	3,610	3030	
Contrapluma 1 Counterjib 1 Contre-flèche 1 Gegenausleger 1 Противовесная консоль 1 الذراع المعاكس 1			4,471	2,290	2,540	9915
Contrapluma 2 Counterjib 2 Contre-flèche 2 Gegenausleger 2 Противовесная консоль 2 الذراع المعاكس 2			4,793	2,290	2,250	8065
Contrapluma 2 + Elevación pluma + pasteca Counterjib 2 + Luffing mech + Reeving block Contre-flèche 2 + Relevage de flèche + Bloc de renvoi Gegenausleger 2 + Auslegerhebwerk + Unterflasche Противовесная консоль 2 + Подъем стрелы + Канифас-болк الذراع المعاكس 2 + رافع الذراع			5,085	2,665	2,725	19250
Elevación pluma / Luffing mech Relevage de flèche / Auslegerhub / Подъем стрелы			2,860	2,480	2,075	7470
Pasteca / Reeving Block Bloc de renvoi / Unterflasche / Канифас-болк			3,340	1,055	2,050	1875
Mecanismo elevacion carga sin cable / Hoisting mechanism without rope / Mécanisme de levage de charge sans câble / Lasthubmechanismus ohne Seil / Подъем груза (without rope) / رافع الحمولة (without rope)			3,190	2,350	1,980	7500
Polipasto / Hook assembly / Palan / Flaschenzug / Полупаст / بكرة		4R 2R/3R TD 	1,380 1,512 0,180	0,525 0,950 0,346	2,600 2,540 2,09	1690 1670 380
Tirante sostén pluma / Jib support tie Tirant de fleche Haltestange Ausleger Растяжка поддержки стрелы / مشد دعامة الذراع			5,416 5,416	0,360 0,360	0,400 0,400	1390 1375
Parte superior + mecanismo auxiliar Top part + auxiliary winch / Partie supérieure + mécanisme auxiliaire / Oberteil + zusätzlicher Mechanismus			11,825	2,300	1,978	17800
Plataforma y cabina (2 x 1,5) / Platform and cabin Plateforme et cabin / Plattform + Führerstand Платформа и кабина / منصة وكابينة / منصة وكابينة			3,670	2,300	2,480	1250
Contrapeso / Counterweight Contrepoids / Gegengewichte / Противовес / اوزان معاكسة			4,500 2,320	0,235 0,235	1,005 1,005	8000 4000
Transporte torre de montaje Jacking cage transport Transport de tour de montage Transport Montageturm Транспортировка монтажной башни نقل برج التركيب		TM20PASP-5,6 Package 1.  Package 2. 	11,610 11,670	2,220 2,010	2,485 2,485	11915 14430

Fecha / Date: 11/10/2022

 **FEM 1005 - C25**



Reservado el derecho a modificaciones sin previo aviso. Declinamos toda responsabilidad derivada de la información proporcionada / Subject to modification, without prior notice. This information is supplied without liability / L'entreprise se réserve le droit de procéder à des modifications sans préavis. Nous déclinons toute responsabilité quant aux informations fournies / Das Recht auf Änderungen ohne vorherige Ankündigung bleibt vorbehalten. Wir übernehmen keine Gewähr für die gemachten Angaben / Мы оставляем за собой право на внесение изменений без предварительного уведомления. Мы снимаем с себя любую ответственность в отношении предоставленной информации / حقوق التغيير محفوظة دون إشعار مسبق. دون أدنى مسؤولية عن المعلومات المقدمة

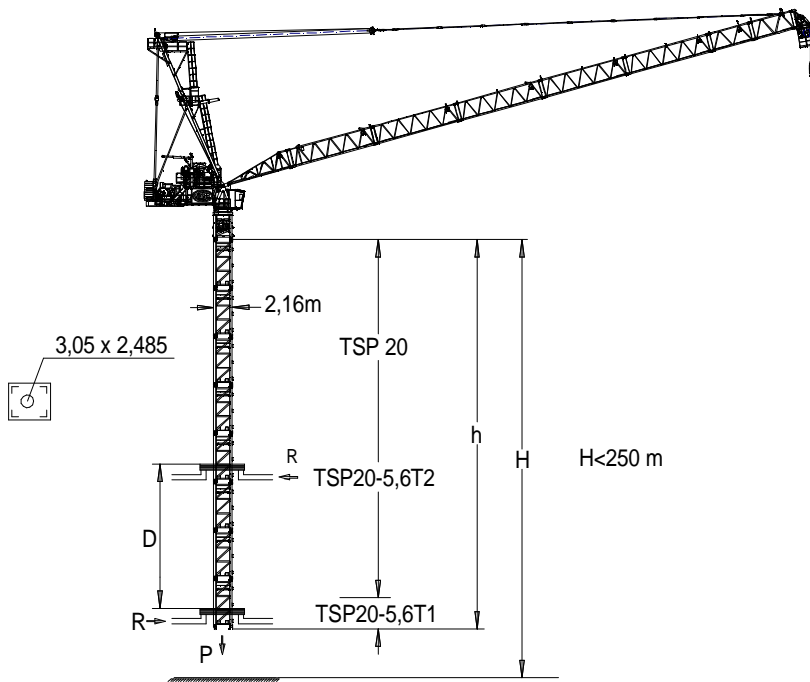

TSP20-5,6T1: 214.31.000  
TSP20-5,6T2: 214.31.500

	Trepado interno / Internal climbing Télescopage intérieur / Inneres klettersystem Внутренняя лестница / التسلق الداخلي
--	--

$h_{max}$ : TSP20-5,6T1 + 6xTSP20-5,6 + TSP20-5,6T2

	TD	▶	■
70 m.			
h (m)	44,8		
D (m)	14,5 – 20,9		
P (KN)	3000	2720	
Rmax (KN)	830	1455	

$h_{max}$ : TSP20-5,6T1 + 6xTSP20-5,6 + TSP20-5,6T2

	2R	▶	■
65 m.			
h (m)	44,8		
D (m)	14,5 – 20,9		
P (KN)	3105	2785	
Rmax (KN)	815	1460	

$h_{max}$ : TSP20-5,6T1 + 6xTSP20-5,6 + TSP20-5,6T2

	3R	▶	■
60 m.			
h (m)	44,8		
D (m)	14,6 – 20,9		
P (KN)	3255	2775	
Rmax (KN)	825	1450	

$h_{max}$ : TSP20-5,6T1 + 6xTSP20-5,6 + TSP20-5,6T2

	4R	▶	■
55 m.			
h (m)	44,8		
D (m)	13,9 – 20,9		
P (KN)	3355	2715	
Rmax (KN)	875	1480	

- Viento fuera de servicio / Out of service wind / Vitesse du vent hors service / Wind außer betrieb / Ветровая нагрузка в покое / الريح خارج الخدمة
- Consultar / Consult / Nous consulter / Anfragen / Консультируйтесь / الرجوع إلى
- En servicio / In service / En service / In betrieb / В работе / في الخدمة
- Fuera de servicio / Out of service / Hors service / Außer betrieb / В покое / خارج الخدمة



Ctra./Rd. Madrid - Irún Km. 415 - 20.213 IDIAZABAL [Gipuzkoa] ESPAÑA / SPAIN  
P.O. Box, 23 - 20.200 BEASAIN - E-mail: jaso@jaso.com  
Tel. +34 943 - 18 70 00 • Fax. +34 943 - 18 70 20  
[www.jaso.com](http://www.jaso.com)

Fecha / Date: 11/10/2022



FEM 1005-C25

DELEGACION / DEALER

Reservado el derecho a modificaciones sin previo aviso. Declinamos toda responsabilidad derivada de la información proporcionada / Subject to modification, without prior notice.  
This information is supplied without liability / L'entreprise se réserve le droit de procéder à des modifications sans préavis. Nous déclinons toute responsabilité quant aux informations  
fournies / Das Recht auf Änderungen ohne vorherige Ankündigung bleibt vorbehalten. Wir übernehmen keine Gewähr für die gemachten Angaben / Мы оставляем за собой право  
на внесение изменений без предварительного уведомления. Мы снимаем с себя любую ответственность в отношении предоставленной информации

حقوق التغيير محفوظة دون إشعار مسبق. دون أدنى مسؤولية عن المعلومات المقدمة